

ML2016

Model	ML2016	
System	(Li-Al) alloy-Manganese Dioxide/Organic Electrolyte	
Nominal Voltage (V)	3	
Nominal Capacity (mAh)*	25	
Nominal Discharge Current (μA)	200	
Charge/Discharge Cycle Lifetime		
Depth of Discharge = 10%	1,500 (2.5 mAh discharge) (total capacity 3,750 mAh)	
Depth of Discharge = 20%	500 (5 mAh discharge) (total capacity 2,500 mAh)	
Temperature Ranges (deg. C)	min.	max.
Operating	-20	+60
Weight (g)**	1.8	
Dimensions (mm)**		
Diameter	20	
Height	1.6	
UL Recognition	MH12568 (N)	

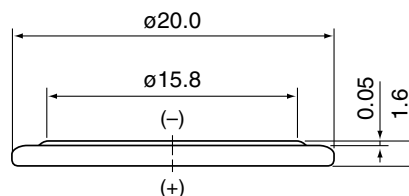

Available Terminals and Wire Connectors

Check http://www.maxell.co.jp/e/products/industrial/battery/pdf/ml2016e_.pdf for diagrams of batteries with terminals.

Characteristics

● Charge Property

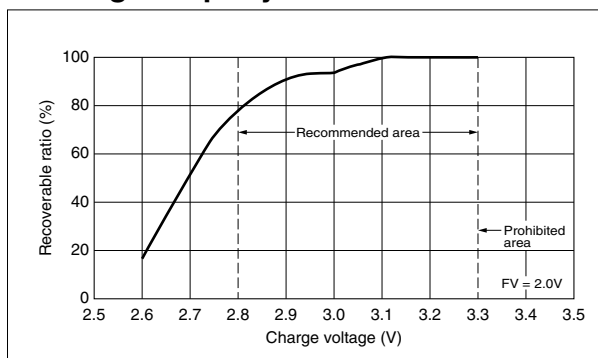

● Discharge Characteristics

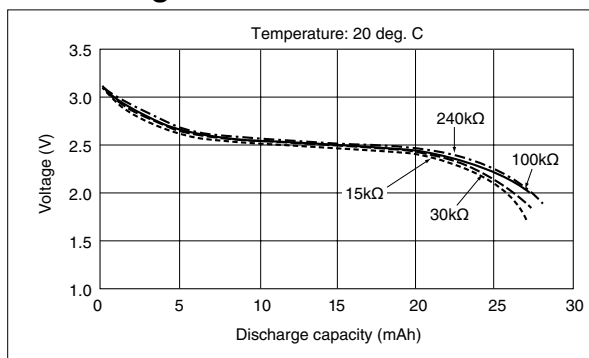

● Temperature Characteristics

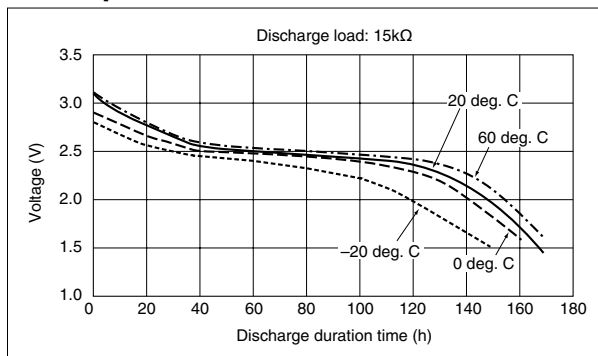

● Relationship between Discharge Current and Duration Time

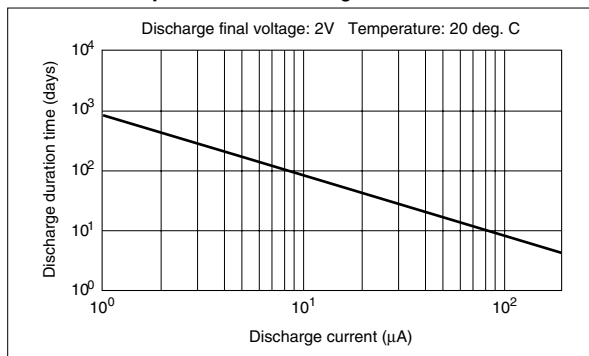

Characteristics

● High Rate Discharge Characteristics

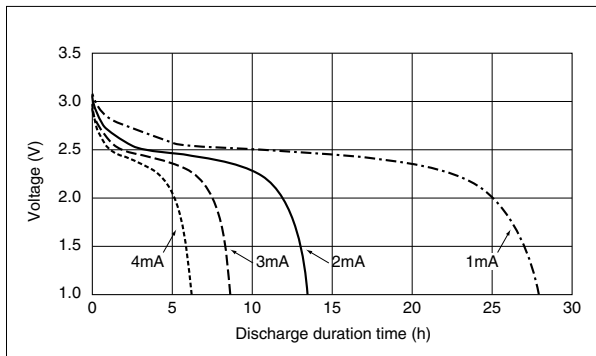

● Floating Charge Characteristics

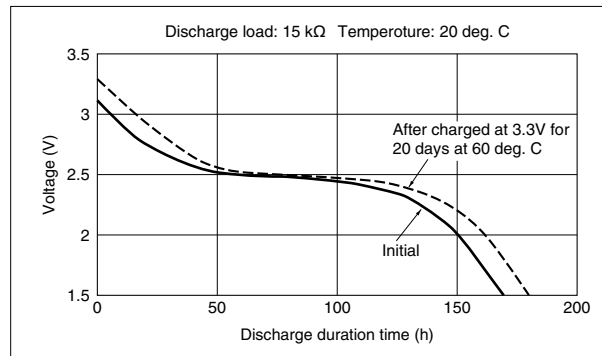

● Storage Characteristics

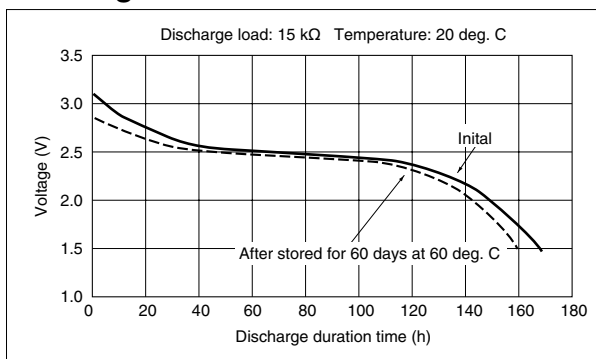

* Nominal capacity indicates duration until the voltage drops down to 2.0V when discharged at a nominal discharge current at 20 deg. C.

** Dimensions and weight are for the battery itself, but may vary depending on the shape of terminals or other factors.

ML Lithium Manganese Dioxide Rechargeable Batteries

Safety Instructions

This battery contains lithium, organic solvents, and other combustible materials. For this reason, improper handling of the battery could lead to distortion, leakage*, overheating, explosion, or fire, causing bodily injury or equipment trouble. Please observe the following instructions to prevent accidents.

* Leakage is defined as the unintentional escape of a liquid from a battery.

WARNING Handling

- **Never swallow.**

Always keep the battery out of the reach of infants and young children to prevent it from being swallowed. If swallowed, consult a physician immediately.

- **Do not replace.**

Depending on the battery manufacturer, there might be major differences in performance even among the same types or models of batteries. If you are an equipment manufacturer and need to replace the battery, please use a new one of the same type and same model as the existing one. Because this is a rechargeable battery, its characteristics are completely different from a primary battery even though their shapes are alike. If a primary battery is installed in the circuit in place of a rechargeable battery, gas could be generated or the primary battery could be short-circuited by charging. This could lead to distortion, leakage, overheating, explosion, or fire. Please design your equipment so that the end user cannot replace the battery by mistake.

- **Never use two or more batteries connected in series or in parallel.**

If batteries are connected together, it is very difficult to design a circuit to observe whether or not the batteries are charged at specified voltage or current as described in "Warning -Circuit Design".

- **Never reverse the positive and negative terminals when mounting.**

Improper mounting of the battery could lead to equipment trouble or short-circuiting. This could cause distortion, leakage, overheating, explosion, or fire.

- **Never short-circuit the battery.**

Do not allow the positive and negative terminals to short-circuit. Never carry or store the battery with metal objects such as a necklace or hairpin. Please be careful when installing the battery not to short-circuit it with metal portions of the equipment. Otherwise, this could lead to distortion, leakage, overheating, explosion, or fire.

- **Never heat.**

Heating the battery to more than 100 deg. C could increase the internal pressure, causing distortion, leakage, overheating, explosion, or fire.

- **Never expose to open flames.**

Exposing to flames could cause the lithium metal to melt, causing the battery to catch on fire and explode.

- **Never disassemble the battery.**

Do not disassemble the battery, because the separator or gasket could be damaged, leading to distortion, leakage, overheating, explosion, or fire.

- **Never weld the terminals or solder a wire to the body of the battery directly.**

The heat of welding or soldering could cause the lithium to melt or cause damage to the insulating material in the battery, leading to possible distortion, leakage, overheating, explosion, or fire. When soldering the battery directly to equipment, solder only the tabs or leads. Even then, the temperature of the soldering iron must be below 350 deg. C and the soldering time less than 5 seconds. Do not use a soldering bath, because the circuit board with battery attached could stop moving or the battery could drop into the bath. Moreover, do not use excessive solder, because the solder could flow to unwanted portions of the board, leading to a short-circuit or charging of the battery.

- **Never allow liquid leaking from the battery to get in your eyes or mouth.**

Because this liquid could cause serious damage, if it does come in contact with your eyes, flush them immediately with plenty of water and consult a physician. Likewise, if the liquid gets in your mouth, rinse immediately with plenty of water and consult a physician.

- **Keep a leaking battery away from fire.**

If leakage is suspected or you detect a strange odor, keep the battery away from fire, because the leaked liquid could catch on fire.

- **Never touch the battery electrodes.**

Do not allow the battery electrodes to come in contact with your skin or fingers. Otherwise, the moisture from your skin could cause a discharge of the battery, which could produce certain chemical substances causing you to receive a chemical burn.

WARNING Circuit Design

- **Never set the charge voltage above 3.3V.**

Charging at a higher voltage could cause the generation of gas, internal short-circuiting, or other malfunctions, leading to distortion, leakage, overheating, explosion, or fire. For details, see the recommended circuits in the figure below.

- **Always charge at the nominal currents shown below.**

Large surges of current could degrade the battery's characteristics, leading to distortion, leakage, overheating, explosion, or fire. To avoid excessive current at the initiation of charging, make sure to attach protective resistance for current control. See the recommended circuits below.

Table 1 Nominal Charge Current by Model

Model	ML2032	ML2016	ML1220
Charge Current	2mA or lower	2mA or lower	1mA or lower

ML Lithium Manganese Dioxide Rechargeable Batteries

• Recommended circuits

Please refer to the representative basic circuits shown below. If you have any questions about circuit design, please feel free to contact Maxell.

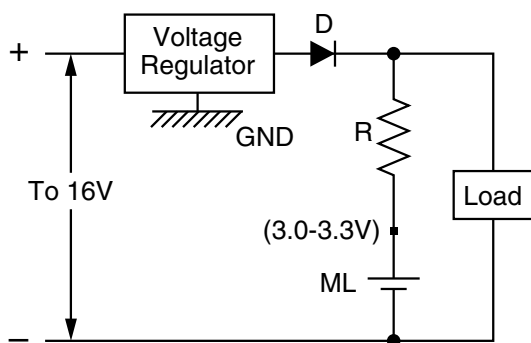

D: Diode; R: Resistance

Table 2 Example of resistance

Model	Output Voltage of Voltage Regulator	
	3.1V	3.2V
ML2032	> 550 ohm	> 600 ohm
ML2016	> 550 ohm	> 600 ohm
ML1220	> 1.1K ohm	> 1.2K ohm

• How to select the protective resistance for the current control

The maximum charge current flows in the battery when charged at an end voltage of 2V. Therefore, the value of resistance is calculated using this equation:

$$(R) \geq ((\text{Output Voltage of Voltage Regulator}) - 2) / (\text{Nominal Charge Current})$$

For example, the S-812C series, which has a maximum input voltage of 18V, or the S-817 series with a maximum input voltage of 10V (Seiko Instruments Inc.) can be used as a voltage regulator.

Note 1: If the main power source voltage is stable, the charge voltage can be allotted from main power source divided by the combination of resistances.

Note 2: Because the battery height must be changed by the charge and discharge cycle, place a minimum of 1mm of space between the battery and device or chassis.

WARNING Disposal

The battery may be regulated by national or local regulation. Please follow the instructions of proper regulation. As electric capacity is left in a discarded battery and it comes into contact with other metals, it could lead to distortion, leakage, overheating, or explosion, so make sure to cover the (+) and (-) terminals with friction tape or some other insulator before disposal.

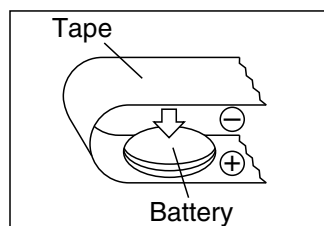

Example of vattery insulation

CAUTION Handling/Storage

• **Use within the rated temperature range of - 20 to + 60 deg C.**

Otherwise, the battery's charge and discharge characteristics may be reduced.

• **Never expose the battery to ultrasonic sound.**

Exposing the battery to ultrasonic sound may cause short-circuiting because the inside material is broken into pieces, leading to distortion, leakage, overheating, explosion, or fire.

• **Never subject the battery to severe shock.**

Dropping, throwing, or stomping on the battery may cause distortion, leakage, overheating, explosion, or fire.

• **Never use or leave the battery in a hot place such as under the direct rays of the sun or in a car in hot weather.**

If you do, this may cause distortion, leakage, overheating, explosion, or fire.

• **Never allow the battery to come in contact with water.**

If it does, this may cause the battery to rust or lead to distortion, leakage, overheating, explosion, or fire.

• **Never store the battery in a hot and highly humid environment.**

Doing so may cause the performance of the battery to deteriorate. In certain environments, this may lead to distortion, leakage, overheating, explosion, or fire.

* Nominal capacity indicates duration until the voltage drops down to 2.0V when discharged at a nominal discharge current at 20 deg. C.

** Dimensions and weight are for the battery itself, but may vary depending on the shape of terminals or other factors.